



DCT-42

Digital/Analog Stereo Audio Amplifier



Operation Manual

DISCLAIMERS

The information in this manual has been carefully checked and is believed to be accurate. Cypress Technology assumes no responsibility for any infringements of patents or other rights of third parties which may result from its use.

Cypress Technology assumes no responsibility for any inaccuracies that may be contained in this document. Cypress also makes no commitment to update or to keep current the information contained in this document.

Cypress Technology reserves the right to make improvements to this document and/or product at any time and without notice.

COPYRIGHT NOTICE

No part of this document may be reproduced, transmitted, transcribed, stored in a retrieval system, or any of its part translated into any language or computer file, in any form or by any means—electronic, mechanical, magnetic, optical, chemical, manual, or otherwise—without express written permission and consent from Cypress Technology.

© Copyright 2017 by Cypress Technology.

All Rights Reserved.

TRADEMARK ACKNOWLEDGMENTS

All products or service names mentioned in this document may be trademarks of the companies with which they are associated.





SAFETY PRECAUTIONS

Please read all instructions before attempting to unpack, install or operate this equipment and before connecting the power supply.

Please keep the following in mind as you unpack and install this equipment:

- Always follow basic safety precautions to reduce the risk of fire, electrical shock and injury to persons.
- To prevent fire or shock hazard, do not expose the unit to rain, moisture or install this product near water.
- Never spill liquid of any kind on or into this product.
- Never push an object of any kind into this product through any openings or empty slots in the unit, as you may damage parts inside the unit.
- Do not attach the power supply cabling to building surfaces.
- Use only the supplied power supply unit (PSU). Do not use the PSU if it is damaged.
- Do not allow anything to rest on the power cabling or allow any weight to be placed upon it or any person walk on it.
- To protect the unit from overheating, do not block any vents or openings in the unit housing that provide ventilation and allow for sufficient space for air to circulate around the unit.

REVISION HISTORY

VERSION NO.	DATE (DD/MM/YY)	SUMMARY OF CHANGE
VS1	11/12/17	Preliminary release



CONTENTS

1. Introduction	1
2. Applications	1
3. Package Contents	1
4. System Requirements	1
5. Features	2
6. Operation Controls and Functions	2
6.1 Front Panel	2
6.2 Rear Panel.....	3
6.3 RS-232 Protocol.....	4
6.4 RS-232 Commands.....	5
7. Connection Diagram	7
8. Specifications	8
8.1 Technical Specifications	8
8.2 Audio Specifications	9
9. Acronyms	10





1. INTRODUCTION

This Digital/Analog Stereo Audio Amplifier is a compact, high performance, Class-D amplifier which features both digital and analog inputs. Volume and input selection can be controlled via front panel buttons or RS-232. LED indicators provide selection and feature information. This unit is designed for both the commercial and residential user who needs to output a high quality source to local analog speakers.

2. APPLICATIONS

- Entertainment rooms & home theaters
- Home sound system extension
- Lecture hall presentations
- Conference and meeting room audio system sharing
- Showroom audio extension

3. PACKAGE CONTENTS

- 1×Digital/Analog Stereo Audio Amplifier
- 2×Terminal Blocks (2-Pin)
- 1×Terminal Block (3-Pin) to RS-232 (9-Pin D-Sub) Cable
- 1×24V/2.7A DC Power Adaptor
- 1×Power Cord
- 1×Operation Manual

4. SYSTEM REQUIREMENTS

- Audio source equipment such as a PC, media player, or smart phone.
- Analog audio receiving equipment such as unpowered speakers.

5. FEATURES

- Compact and cost-effective amplifier design
- High performance and efficient Class-D amplifier
- Selectable analog and digital audio inputs
- Volume control with mute
- Simple control via front panel buttons and RS-232

6. OPERATION CONTROLS AND FUNCTIONS

6.1 Front Panel

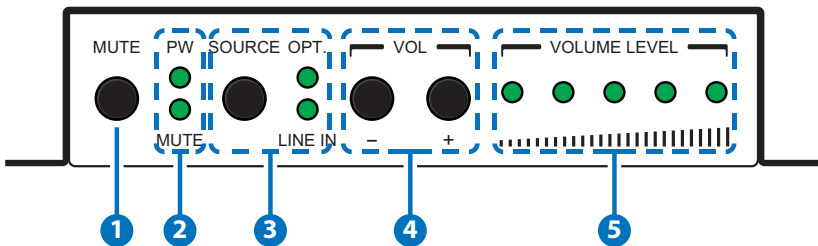

- 1 MUTE Button:** Press to toggle between muting and unmuting the audio output.

Note: Press and hold this button for 3 seconds to put the unit into stand-by mode. Press and hold the button again for 3 seconds to return to normal operation.

- 2 PW LED:** This LED will illuminate bright green to indicate the unit is on and receiving power. When the unit is in stand-by mode the LED will illuminate dim green.

MUTE LED: This LED will illuminate to indicate the when the audio output is muted.

- 3 SOURCE Button & OPT./LINE IN LEDs:** Press this button to toggle between the line in and optical inputs. The LEDs will illuminate to indicate which source is currently selected.

- 4 VOL -/+ Buttons:** Press or hold the -/+ (minus/plus) buttons to increase or decrease the audio output volume.

- 5 VOLUME LEVEL LEDs:** These 5 LEDs will illuminate progressively from

left (lowest) to right (highest) to indicate the current output volume level.

Note: The full volume range is from -80dB to +20dB (100 steps) and the LEDs will be lit proportionally to this range.

6.2 Rear Panel

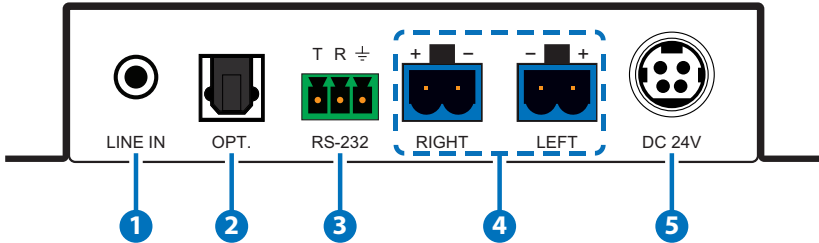

- 1 LINE IN:** Connect to the stereo analog output of a device such as a CD player or PC.
- 2 OPT. IN:** Connect to the optical audio output of a device such as a media player or game console using an appropriate optical cable.
- 3 RS-232:** Connect directly to a PC, laptop or other serial control device with a 3-pin adapter cable to send RS-232 commands to control the unit.
- 4 RIGHT/LEFT OUT:** Connect to unpowered speakers (20W, 4Ω) for stereo analog audio output.
- 5 DC 24V:** Plug the 24V DC power adapter into the unit and connect it to an AC wall outlet for power.

6.3 RS-232 Protocol

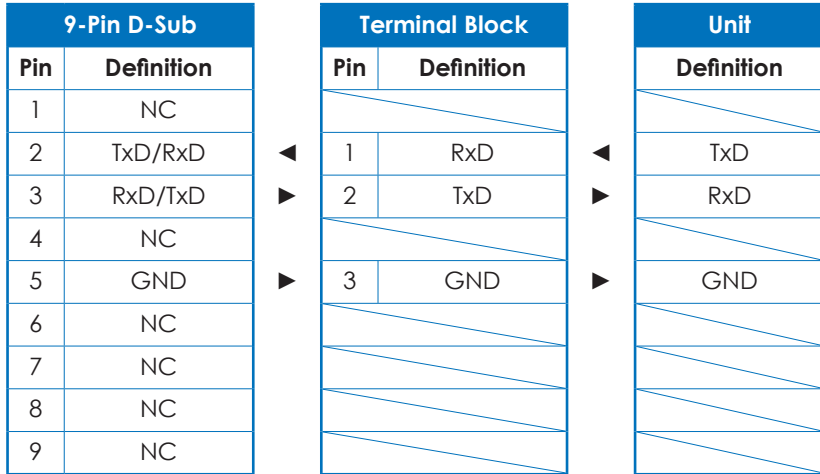

Baud Rate: 19200bps

Data Bits: 8

Parity Bits: None

Stop Bits: 1

Flow Control: None

6.4 RS-232 Commands

COMMAND	DESCRIPTION AND PARAMETERS
System Commands	
HELP ↵	Show the full command list.
? ↵	Show the full command list.
GET FW VER ↵	Show the unit's firmware version.
GET MODEL NAME ↵	Show the unit's model name.
SET FACTORY DEFAULT ↵	Reset all settings to the factory defaults.
SET POWER N1 ↵	Set the units power state to on or stand-by. Available values for N1: ON [Power On] STANDBY [Stand-by Mode]
GET POWER ↵	Show the unit's current power state.
SET SYSTEM REBOOT ↵	Reboot the unit.

COMMAND	DESCRIPTION AND PARAMETERS
Audio Commands	
SET AUDIO OUT A MUTE N1 ↵	Enable or disable mute on the audio output. Available values for N1: OFF [Un-Mute] ON [Mute]
GET AUDIO OUT A MUTE ↵	Show the current audio output mute state.
SET AUDIO OUT A ROUTE N1 ↵	Set the audio input source. Available values for N1: 1 [Line In] 2 [Optical]
GET AUDIO OUT A ROUTE ↵	Show the current audio input source.

COMMAND	DESCRIPTION AND PARAMETERS
Audio Commands	
SET AUDIO OUT A VOLUME N1↵	Set the audio output volume. N1 = 0 ~ 100 [dB Units] Volume Mapping Table: 100 [+20dB] 80 [0dB] 60 [-20dB] 40 [-4dB] 20 [-60dB] 0 [-80dB]
SET AUDIO OUT A VOLUME UP↵	Increase the audio output volume by 1 step (up to a max of 100).
SET AUDIO OUT A VOLUME DOWN↵	Decrease the audio output volume by 1 step (down to a min of 0).
GET AUDIO OUT A VOLUME↵	Show the current audio output volume.

Note: Commands will not be executed unless followed by a carriage return. Commands are not case-sensitive.

7. CONNECTION DIAGRAM

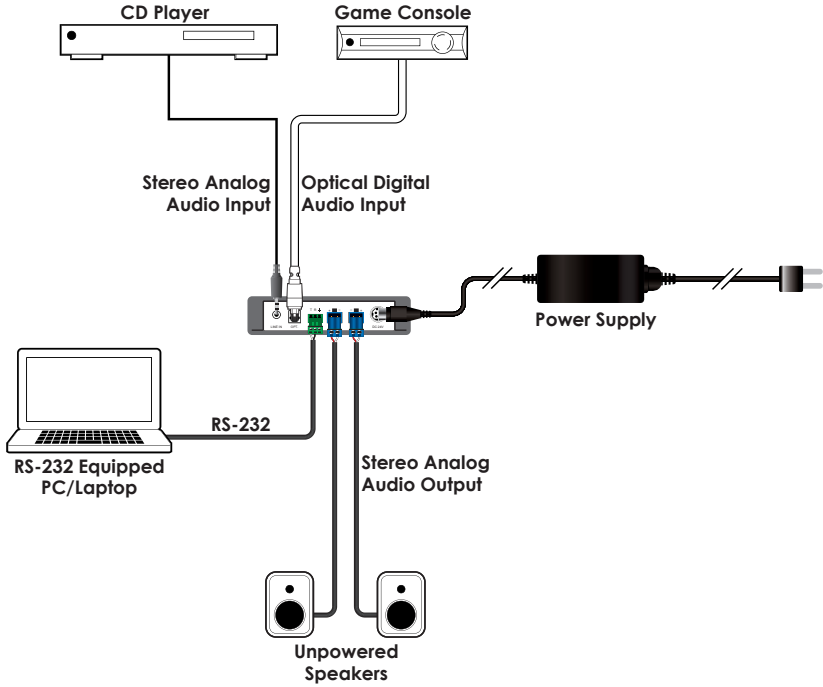

8. SPECIFICATIONS

8.1 Technical Specifications

Input Ports	1×Optical (S/PDIF Audio) 1×3.5mm (Stereo Audio)
Output Ports	2×Terminal Block (Speakers)
Control Interface	1×RS-232 [Terminal Block]
Power Supply	24V/2.7A DC (US/EU standards, CE/FCC/ UL certified)
ESD Protection	Human Body Model: ±8kV (Air Discharge) ±4kV (Contact Discharge)
Dimensions	128mm×25mm×108mm (W×H×D) [Case Only] 128mm×25mm×110mm (W×H×D) [All Inclusive]
Weight	380g
Chassis Material	Metal
Silkscreen Color	Black
Operating Temperature	0°C - 40°C/32°F - 104°F
Storage Temperature	-20°C - 60°C/-4°F - 140°F
Relative Humidity	20 - 90% RH (Non-condensing)
Power Consumption	42W



8.2 Audio Specifications

Amplifier Output	
Output Power	20W+20W
THD+N	0.02% (Po = 1W, Load = 4Ω)
Frequency Response	20Hz ~ 20kHz
SNR	95dB
Crosstalk	80dB

Optical (S/PDIF) Input	
Sampling Rate	44.1, 48, 88.2, 96, 176.4, 192 (kHz)

Line-level Input	
Input Sensitivity	210mV
Input Impedance	30KΩ
Audio Format	LPCM 2.0
Full Scaler	2.1Vrms
THD+N	85dB (Level = -1dB)
Frequency Response	20Hz ~ 20kHz (±0.5dB)
SNR	95dB
Crosstalk	80dB

9. ACRONYMS

ACRONYM	COMPLETE TERM
dB	Decibel
Hz	Hertz
kHz	Kilohertz
OPT	Optical
S/PDIF	Sony/Philips Digital Interface Format
SNR	Signal-to-Noise Ratio
THD+N	Total Harmonic Distortion plus Noise
VOL	Volume
W	Watts
Ω	Ohm



CYPRESS TECHNOLOGY CO., LTD.

www.cypress.com.tw